

Programmable 4.0GHz RF over Fiber



Key Features:

- Next generation RFoF modules with significant performances improvement.
- Supports up to 4.0GHz.
- Better linearity, excellent gain flatness, and Tx, Rx and Link gain control.
- Noise Figure down to 6 dB with LNA with MDS ~-168 dB/Hz for very low incoming signals.
- Internal microcontroller allows RF and Optical control, enabled by software.
- End-to-end diagnostics reduces installation and maintenance time, enabled by software.
- Gain variation S21 (fo) of ± 1 dB for 90° C variation, utilizing special algorithm.
- Remote management by GUI installed on PC.
- Impedances of 50 Ohms and 75 Ohm

Monitoring:

- Managed remotely by software or locally through navigation switch

Configurations:

- Outdoor enclosure (unidirectional/bi-directional)
- 1U Generic enclosure (4 units)
- (1,2,3)U Removable panel enclosure (4/8/12) units

Applications:

- Remote Antennas Communication
- Satcom
- 4G LTE
- Broadcast
- Distributed Antenna
- Radio telescopes

RFOptic's innovative controllable RFoF product line consists of palm size analog RFoF modules that are used to convert RF signals to optical signals to carry over long distances. The Tx unit using an optical transmitter, converts RF to Optical signal and the Rx unit converts back to RF signal. The two units are connected through customer's single mode fiber.

RFOptic's RF over Fiber modules (RFoF) are suitable for telecommunications, satellite, radio telescopes, distribution antennas, broadcasting audio and video, and timing synchronization. For example, point-to-point antennas can be connected from several meters to many kilometers away from the control room by fiber cables; Base stations can be connected through fiber to remote sector antennas; Satellite antennas can be connected through fiber cable to remote sites by RF over Fiber solutions.

Both the Tx and Rx units includes LNAs and variable attenuators that enable customer to adjust the Noise Figure, Input P1dB, and IP3 with wide dynamic range values. The LNA can be operated through the RFoF software allowing RF input power in the range of -100 dBm/1MHz for wideband applications, with low Noise Figure of 6 dB. The RFoF link has excellent gain flatness with 0.5dB gain tracking between different links. For special applications requiring temperature stability operation, a unique algorithm supporting 0.5 dB over 1000C has been developed. The DC power of the RFoF modules is flexible from 5 to 12 Volts.

A user-friendly RFoF software enables adjustment of the RF and Optical parameters, such as link gain, Noise Figure, P1dB, Optical power, LED indication and module information, either locally or remotely.

Furthermore, the RFoF link has full diagnostic capability including Tx, Rx and complete link test (Optical and RF). These features save cost of test equipment and provide real time diagnostic of any deployed link.

The [link gain calculator](#) helps to calculate the link gain and the optical predicted parameters for RFOptic's programmable RFoF family.

Programmable 4.0GHz RF over Fiber specifications

Electrical	Unit	Specification LNA "OFF"	Specification LNA "ON"
Frequency Range	MHz	0.5 - 4000	0.5 - 4000
Adjustable Link Gain (nominal value) ^[1]	dB	12	42
Attenuator 31 dB (Tx, Rx) ^[2]	dB	0.5	0.5
Gain Flatness	dB	±2.0	±2.0
Input P1 dB ^[3]	dBm	-3	-33
Noise Figure ^[3]	dB	23	6.5
SFDR ^[3]	dB/Hz ^{2/3}	104	100
Gain Flatness any 36 MHz	dB	±0.25	±0.25
Uncorrected gain variation over temperature	dB	±3.5	±3.5
Corrected gain variation over temperature ^[4]	dB	±1	±1
Corrected gain tracking between RFoF links ^[5]	dB	±0.5	±0.5
Maximum Input No damage	dBm	20	20
Spurious	dBm	-100	-100
VSWR Input / Output	dBm	1.7:1	1.7:1
Input / Output impedance ^[6]	Ohm	50	50
Optical and Electrical			
Current consumption of Tx unit (at 5VDC)	mA	260	385
Current consumption of Rx unit (at 5VDC)	mA	225	225
Laser diode wavelength	µm	1.31 or 1.55	1.31 or 1.55
Optical Power in the fiber	mw	2.3 ±0.5	2.3 ±0.5
LED status indicators (Tx/Rx)	-	RGB	RGB
Mechanical and Environmental Parameters			
Operating temperature	°C	-20 to +70	-20 to +70
Storage temperature	°C	-40 to +85	-40 to +85
EMC and Safety ^[7]	-	CE & FCC	CE & FCC

RFoF 4.0GHz module options:

Parameter	RFoF Tx/Rx Units	19" 1U Enclosure for RFoF	RFoF 4.0GHz Outdoor
Dimensions (mm)	70(W)*70(L)*22(H)	19" 1U Generic: 445(W)*476(L)*44(H) 19" 1U Removable: 442(W)*402(L)*44(H)	Large Outdoor: 330(W)*350(L)*85(H) Small Outdoor: 270(W)*230(L)*85(H)
Number of units	-	Up to 8 Up to 4	Up to 6 Up to 4
RF I/O Connector	SMA female	SMA female	N Type female
Optical Connector	FC/APC or SC/APC	FC/APC or SC/APC	MPO/APC 4/8 male ^[10]
Data Connector	Micro USB ^[8]	USB2/RJ-45	RJ45 female ^[11]
Power Connector	PIN 3.5*1.3*9 mm ^[9]	HP Socket	DC female/ AC male ^[11,12]
Power	5-12 VDC	110/220 VAC	9-36 DC / 110/220VAC ^[11,12]

[1] LNA 'ON' or 'OFF' is selected by RFOptic manufacturing, or by using the RFoF user software.

[2] 'No Attenuation' is the default for Tx and Rx units. Attenuation values can be selected by the user software.

[3] Noise Figure, Input P1 dB, Input IP3 and SFDR measured at 1.5GHz, can be selected by 'LNA Off/ON' and Tx Attenuator.

[4] Using internal temperature compensation algorithm selected by the user software.

[5] Using the Tx and/or Rx Attenuators.

[6] 75 Ohm is optional with similar VSWR, by using SMA/BNC adaptor.

[7] Safety EN60950-1:2006(2nd); EMC: ETSI EN 300 386 v1.6.1 (2012-04) and FCC CFR-47 part 15 Sub part B.

[8] For USB control, download software here: rfoptic.com/software-download-rfof/ (ask your local representative for password)

[9] 2 cables clamps to secure the power adapters cables of the Tx and the Rx can also be provided.

[10] MPO 4/8 optical cable (female) should be ordered by the customer according to the required length and conditions.

Example: GoFoton: P/N BPF3P1SM015FLR020 (4 fibers)/BPF3P1FM015FLR021 (8 fibers). XXX = 015m fiber length.

[11] IP67 Data, AC and DC opposite connectors are provided as accessories with the module (cables are not included).

[12] DC and AC versions of the outdoor enclosures are available.

Programmable 4.0GHz RFoF Version October2022

Tel. Int.:+ 972-76-540 0771 • Tel. USA: +1 732 543 5738

Yagia Kapaim 21, Building C, 3rd Floor 4913020 Petah Tikva, Israel

www.rfoptic.com

Programmable 4.0GHz RFoF – Simplified Block Diagram

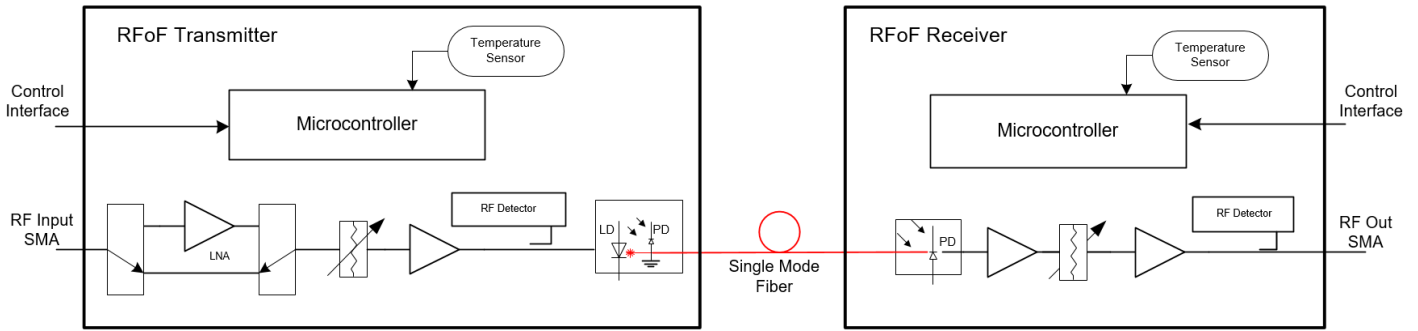

Programmable 4.0GHz RFoF - Test Results (Typical performance with Tx and Rx attenuators set to 0dB)

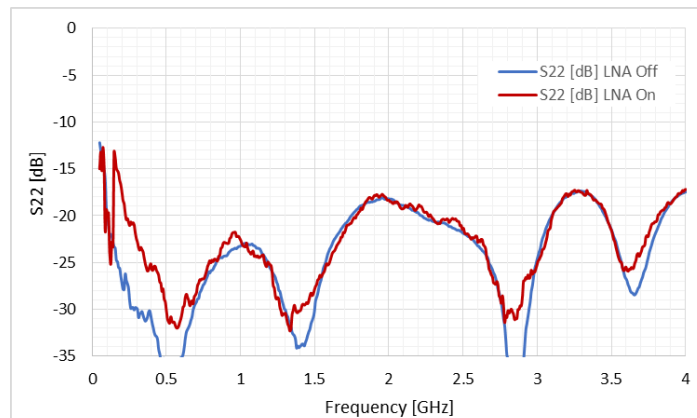
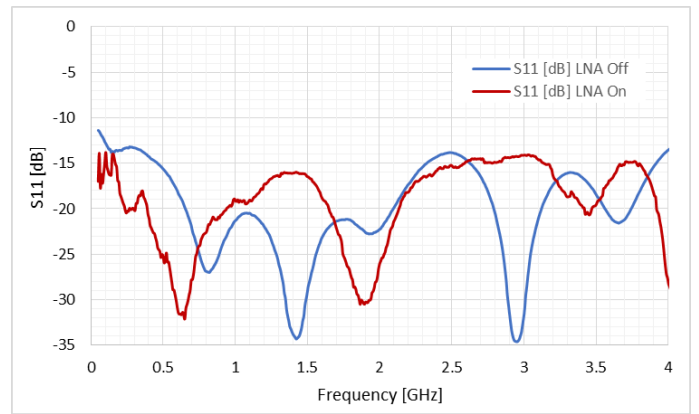
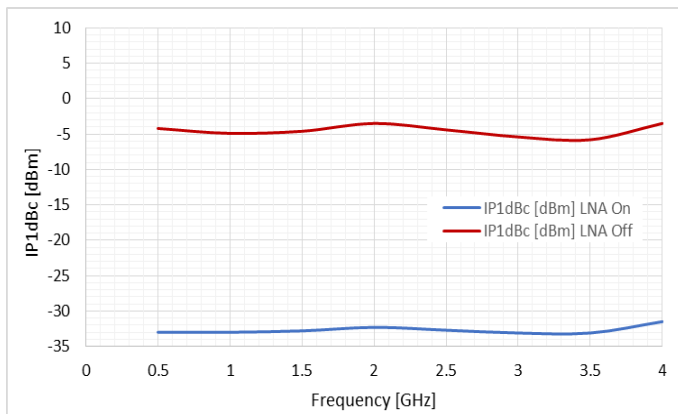
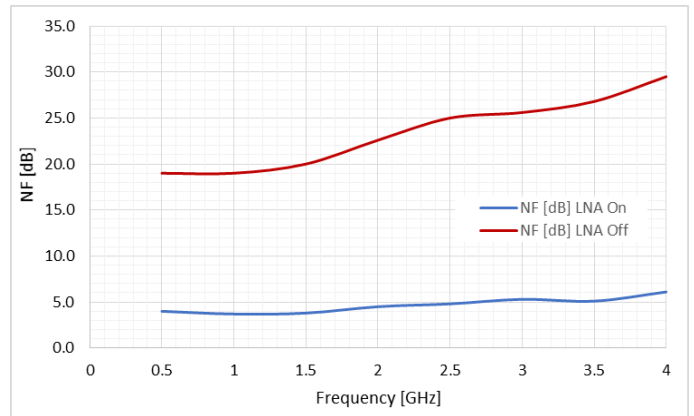
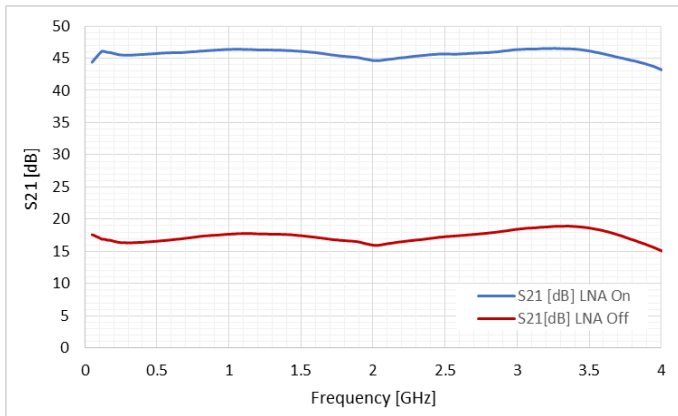

Mechanical Outline Drawing: Programmable 4.0GHz RFoF Rx & Tx units

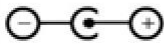
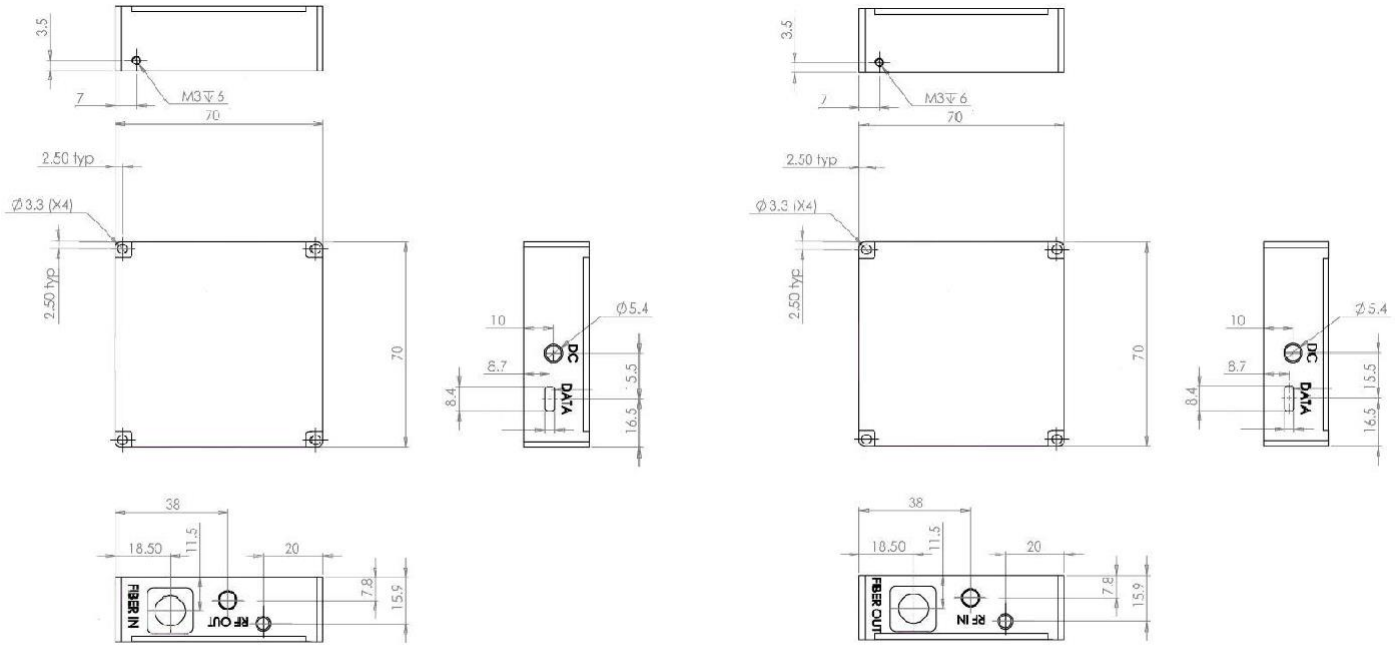

Connector: Positive center plug OD: 3.5mm, ID: 1.3mm, L: 9mm

Ordering Information

Part Number	Product Description	Tx	Rx
RFoF-4.0GHz-1310-Prog.	4.0GHz Transceiver 1310, FC/APC, Programmable	RFoF4T3FR-PA-11	RFoF4R3FR-PA-11
RFoF-4.0GHz-1550-Prog.	4.0GHz Transceiver 1550, FC/APC, Programmable	RFoF4T5FR-PA-11	RFoF4R5FR-PA-11
RFoF-AC-DC-Prog.	2*220/110 AC/5VDC adapter for Programmable *	-	-
RFoF-AC-DC-Prog-1	1*220/110 AC/5VDC adapter for Programmable	-	-

* Since each RFoF module requires one AC/DC adapter, 2 adapters will be needed for a link

Options:

- For outdoor or rack mount options, please contact RFOptic at info@rfoptic.com
- SC/APC adaptor is an option